

moveXX
driven by brain power



Movexx **BT4000**
PARTS & OPTIONS

Aug. **2019**



Specifications

Technical details

Frame	Steel, powder coated,
Motor	3000W, AC
Weight	680 kg
MAX Drawbar pull	4500N
Battery	Build in
Charger	Fronius 24V, 32Ah
Speed Max.	16km/h (adjustable)
Drive wheels	4.00-8 Full Rubber
Turning radius	1865 mm
Step Height	300 mm
Ground Clearance	100 mm
To use from	-10 °C / 40 °C
Protection class	Machine IP44

© 2019 Movexx International B.V. The images shown are used for illustration purposes only and may differ from the products indicated. No rights can therefore be derived from it. Printing errors are subjected to change.

Pulling power (in kg)

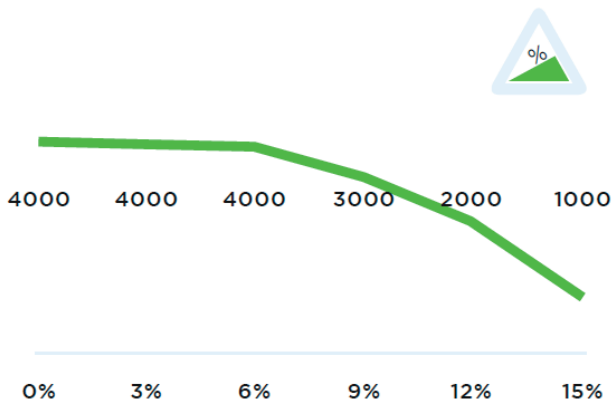

Measured with a trolley with 2 swivel wheels and 2 fixed castors. Wheel Ø 160 mm

Dimensions

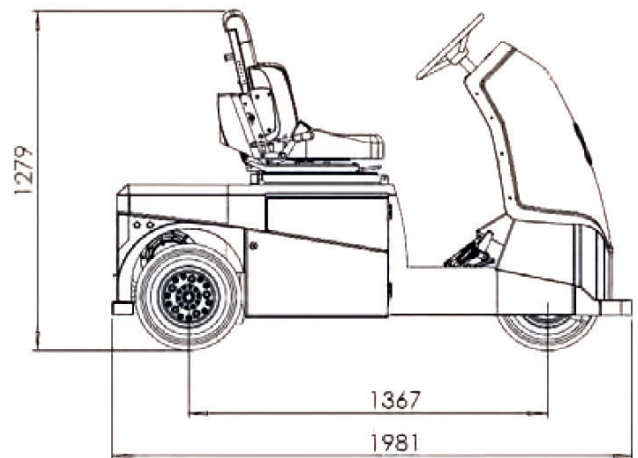
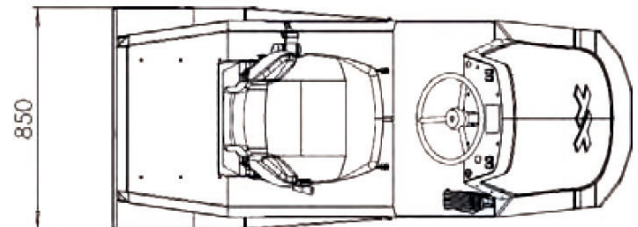

Standard parts

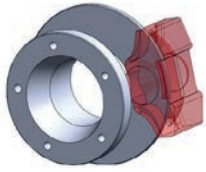

Brake disk
Item number M2866



Shock absorber
Item number M2873



Sit contact on chair
Item number OPT0320



Ignition key (unequal)
Item number OPT0145



Emergency stop complete
Item number M0130



Electro magnetic parking brake
Item number OPT0319

Options



Blue safety spot
Item number OPT0251

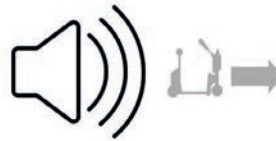

Audio signal (while driving)
Item number OPT0253

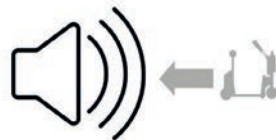

Audio signal (driving backward)
Item number OPT0254



Hour tracker
Item number OPT0056



Antistatic strip
Item number OPT0058



Code lock
Item number OPT0068

Options



Ignition key (equal)
Item number OPT0146



On/off rotary switch
Item number OPT0016



Customized programming
Please indicate specific settings
Item number OPT0170



U-frame for waste container 1000 l. / 1100 l.
Item number OPT0088



USB charger for phone and tablet
Item number OPT0315



Curve speed reduction
Item number OPT0283

Options



Control panel (rear left side)
Item number OPT0284



Control panel (rear right side)
Item number OPT0285



Luxury chair with rail with sit contact
Item number OPT0288



Cabin
Item number M3152



Advanced display
Item number OPT0286



Rear LED lights
Item number OPT0291

Options



Work lamp
Item number OPT0292



7-pin trailer plug
Item number OPT0293



Automatic battery filling system
Item number OPT0294



Battery liquid indicator
Item number OPT0314

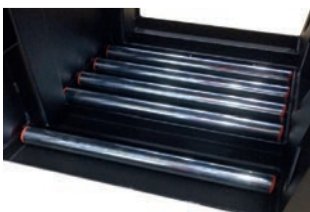

Roll system for easy battery loading
Item number OPT0311



Automatic trailer coupling Ø 25 mm
Item number OPT0312

Options

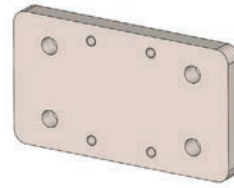

Adapter plate for standard hook
Item number OPT0313



Urgent order purchase
Item number SPOED

Batteries & Chargers



Traction Battery
24V / 300Ah / 5h
Item number OPT0365



Battery charger 24V, 32A
Item number OPT0366

applications



movexx
driven by brain power

ASP
Handling

ASP bvba
Baanakkerweg 3
B-3060 Bertem

+32 (0)16 36 12 24
info@asp-online.be
www.asp-online.be